



CRS-120

1:1 Redundancy Switch Installation and Operation Manual

IMPORTANT NOTE: The information contained in this document supercedes all previously published information regarding this product. Product specifications are subject to change without prior notice.



CRS-120

1:1 Redundancy Switch Installation and Operation Manual

Comtech EF Data is an ISO 9001
Registered Company.

Part Number MN/CRS120.IOM
Revision 3
November 28, 2005



Customer Support

Contact the Comtech EF Data Customer Support Department for:

- Product support or training
- Information on upgrading or returning a product
- Reporting comments or suggestions concerning manuals

A Customer Support representative may be reached at:

Comtech EF Data
Attention: Customer Support Department
2114 West 7th Street
Tempe, Arizona 85281 USA

480.333.2200 (Main Comtech EF Data Number)
480.333.4357 (Customer Support Desk)
480. 333.2161 FAX

or, E-Mail can be sent to the Customer Support Department at:

service@comtechefdata.com

Contact us via the web at www.comtechefdata.com.

1. To return a Comtech EF Data product (in-warranty and out-of-warranty) for repair or replacement:
2. Request a Return Material Authorization (RMA) number from the Comtech EF Data Customer Support Department.
3. Be prepared to supply the Customer Support representative with the model number, serial number, and a description of the problem.
4. To ensure that the product is not damaged during shipping, pack the product in its original shipping carton/packaging.
5. Ship the product back to Comtech EF Data. (Shipping charges should be prepaid.)

For more information regarding the warranty policies, see Warranty Policy, p. xi.

Table of Contents

CHAPTER 1. INTRODUCTION	1-1
1.1 Introduction.....	1-1
1.2 Description	1-2
1.3 Front Panel.....	1-5
1.4 Rear Panel	1-5
1.5 Side Panel - Right Side	1-6
CHAPTER 2. INSTALLATION.....	2-1
2.1 Unpacking	2-1
2.2 Mounting.....	2-1
2.2.1 CRS-120 Optional Mounting Panel.....	2-2
2.2.2 CRS-120L Optional Mounting Panel.....	2-3
2.3 Connect External Cables	2-4
2.2.1 CRS-120 Wiring Connections.....	2-4
2.2.2 CRS-120L Wiring Connections.....	2-5

CHAPTER 3. CONNECTOR PINOUTS	3-1
3.1 External Modem Connections	3-1
3.1.1 Alarm Interface Pin Assignment J1A, J1B	3-2
3.1.2 Online Status Connector Pin Assignments, J2	3-2
3.1.3 CRS-120 Only. TX-IF Connectors, J3, J4, J5, J6A, J6B	3-3
3.1.4 CRS-120L Only. SMA Connectors J3, J4, J5, J6A, J6B	3-3
3.1.5 Standby TX IF Out Switch.....	3-3
CHAPTER 4. OPERATION.....	4-1
4.1 Introduction.....	4-1
4.2 1:1 Operation.....	4-2
4.3 1:1 Remote Control Operation	4-3
CHAPTER 5. SUMMARY OF SPECIFICATIONS.....	5-1
5.1 Summary of Specifications.....	5-1
5.1.1 CRS-120 Summary of Specifications	5-2
5.1.2 CRS-120L Summary of Specifications	5-3
5.2 1:1 Latching Operation	5-4
5.3 Tx Online Status Contacts	5-5

Figures

Figure 1-1. 1:1 Redundancy Switch	1-1
Figure 1-2. Block Diagram	1-3
Figure 1-3. Dimensional Envelope of CRS-120 PL/10979-1.....	1-6
Figure 1-4. Dimensional Envelope of CRS-120L	1-7
Figure 2-1. CRS-120 Optional Mounting Panel.....	2-2
Figure 2-2. CRS-120L Optional Mounting Panel.....	2-3
Figure 2-3. CRS-120 Typical Installation	2-4
Figure 2-4. CRS-120L Typical Installation	2-5
Figure 4-1. Typical View of Modulator Front Panel	4-1

Tables

Table 3-1. CRS-120 Connectors and Pin Assignments	3-1
Table 3-2. CRS-120L Connectors and Pin Assignments	3-1
Table 5-1. CRS-120 Summary of Specifications.....	5-2
Table 5-2. CRS-120L Summary of Specifications.....	5-3
Table 5-3. 1:1 Latching Operation.....	5-4

This page is intentionally left blank.

About this Manual

This manual provides installation and operation information for the Comtech EF Data CRS-120/-120L 1:1 Redundancy Switch. This is a technical document intended for earth station engineers, technicians, and operators responsible for the operation and maintenance of the 1:1 Redundancy Switch.

Conventions and References

Cautions and Warnings



CAUTION indicates a hazardous situation that, if not avoided, may result in minor or moderate injury. CAUTION may also be used to indicate other unsafe practices or risks of property damage.



WARNING indicates a potentially hazardous situation that, if not avoided, could result in death or serious injury.



Indicates information critical for proper equipment function.

Overview to Changes made to Revision 2

Metric Conversion

Metric conversion information is located on the inside back cover of this manual. This information is provided to assist the operator in cross-referencing English to Metric conversions.

Trademarks

Other product names mentioned in this manual may be trademarks or registered trademarks of their respective companies and are hereby acknowledged.

Reporting Comments or Suggestions Concerning this Manual

Comments and suggestions regarding the content and design of this manual will be appreciated. To submit comments, please contact the Comtech EF Data Customer Support Department.

Safety Notices

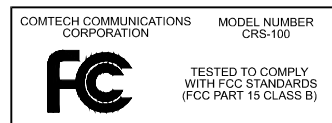
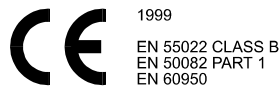

**IMPORTANT INFORMATION –
PLEASE READ BEFORE INSTALLATION AND USE**

Electrical Safety

The 1:1 redundancy switch has been shown to comply with the following safety standard:

EN 60950: Safety of Information Technology Equipment, including electrical business machines

The equipment is rated for operation at +12 volts DC. It has a maximum power consumption of 1.2 watts, and draws a maximum of 100 mA at +12 volts DC. A single modulator is capable of supplying the entire current.

The User should observe the following instructions:

Equipment Connection

The 1:1 redundancy switch is designed for operation ONLY with Comtech CDM-500, CDM-550 or CDM-550T Modems. These Modems supply DC operating current (electronically fused and protected) and control signals for the correct functioning of this unit. Connection to other manufacturer's equipment could result in damage to the unit.

Environmental

The 1:1 redundancy switch must not be operated in an environment where the unit is exposed to extremes of temperature outside the ambient range 0 to 50°C (32 to 122°F), precipitation, condensation, or humid atmospheres above 95% RH, altitudes (un-pressurised) greater than 2000 metres, excessive dust or vibration, flammable gases, corrosive or explosive atmospheres.

Operation in vehicles or other transportable installations which are equipped to provide a stable environment is permitted. If such vehicles do not provide a stable environment, safety of the equipment to EN60950 may not be guaranteed

Telecommunications Terminal Equipment Directive

In accordance with the Telecommunications Terminal Equipment Directive 91/263/EEC, this equipment should not be directly connected to the Public Telecommunications Network.



EMC (Electromagnetic Compatibility)

The 1:1 redundancy switch has been demonstrated, by independent testing, to comply with the following standards:

Emissions: EN 55022 Class B - Limits and methods of measurement of radio interference characteristics of Information Technology Equipment.

FCC Part 15 Class B

Immunity: EN 50082 Part 1 - Generic immunity standard, Part 1: Domestic, commercial and light industrial environment.

In order that the 1:1 redundancy switch continues to comply with these standards, observe the following instructions:

- Connections to the transmit and receive IF ports (BNC female connectors) should be made using a good quality coaxial cable - for example RG58/U (50 Ω) or RG59/U (75 Ω).
- All 'D' type connectors attached to the unit must have back-shells which provide continuous metallic shielding. Cable with a continuous outer shield (either foil or braid, or both) must be used, and the shield must be bonded to the back-shell.
- The equipment must be operated with its cover on at all times. If it becomes necessary to remove the cover, the User should ensure that the cover is correctly re-fitted before normal operation commences.

Warranty Policy

This Comtech EF Data product is warranted against defects in material and workmanship for a period of two years from the date of shipment. During the warranty period, Comtech EF Data will, at its option, repair or replace products that prove to be defective.

For equipment under warranty, the customer is responsible for freight to Comtech EF Data and all related custom, taxes, tariffs, insurance, etc. Comtech EF Data is responsible for the freight charges **only** for return of the equipment from the factory to the customer. Comtech EF Data will return the equipment by the same method (i.e., Air, Express, Surface) as the equipment was sent to Comtech EF Data.

Limitations of Warranty

The foregoing warranty shall not apply to defects resulting from improper installation or maintenance, abuse, unauthorized modification, or operation outside of environmental specifications for the product, or, for damages that occur due to improper repackaging of equipment for return to Comtech EF Data.

No other warranty is expressed or implied. Comtech EF Data specifically disclaims the implied warranties of merchantability and fitness for particular purpose.

Exclusive Remedies

The remedies provided herein are the buyer's sole and exclusive remedies. Comtech EF Data shall not be liable for any direct, indirect, special, incidental, or consequential damages, whether based on contract, tort, or any other legal theory.

Disclaimer

Comtech EF Data has reviewed this manual thoroughly in order that it will be an easy-to-use guide to your equipment. All statements, technical information, and recommendations in this manual and in any guides or related documents are believed reliable, but the accuracy and completeness thereof are not guaranteed or warranted, and they are not intended to be, nor should they be understood to be, representations or warranties concerning the products described. Further, Comtech EF Data reserves the right to make changes in the specifications of the products described in this manual at any time without notice and without obligation to notify any person of such changes.

If you have any questions regarding your equipment or the information in this manual, please contact the Comtech EF Data Customer Support Department.

Chapter 1. INTRODUCTION

1.1 Introduction

The 1:1 Redundancy Switch (Figure 1) is available in either a 70/140 MHz application or an L-Band application to support modulator backup.

- The CRS-120 is a companion product that provides 70/140 MHz switching (75Ω only) for the Comtech EF Data (CEFD) CDM-710 Satellite Modem equipt as a Modulator and is procurable as 1:1 Switch Kit P/N KT/11084-3 consisting of the switch and the necessary installation cables.
- The CRS-120L is an L-Band version of the 1:1 Switch for operation with the L-Band version of the . A 1:1 Switch Kit, KT/ 11362-3 is available for L-Band.

The 1:1 controller is within the modulator and provides control and drive signals to the 1:1 redundancy switch. This combination continuously monitors a pair of modulators so that, in the event of an equipment failure (or an undesired traffic condition), the subsystem automatically switches IF signals from the failed unit to the Standby unit. In this manner, IF traffic paths are fully protected. The CRS-120 / CRS-120L provides IF / L-Band switchover only. It does not support switchover of data circuits.



CRS-120



CRS-120L

Figure 1-1. 1:1 Redundancy Switch



The 1:1 redundancy switch does not support switchover of data circuits.

Accordingly, a 1:1 system comprises an Online Modulator, a Standby Modulator, and the 1:1 redundancy switch Switch.



Note that the 1:1 redundancy switch was designed specifically as an accessory product for the CEFD CDM-710 Satellite Modem, equip as a Modulator, and is not intended for use with any other manufacturer's equipment.



Read this specification in conjunction with the specifications for the CDM-710 , as details of the operation of that equipment is not covered in this document.

1.2 Description

The 1:1 redundancy switch connects two modulators, an Online unit and a Standby unit. It monitors the fault status of these two units, and controls the routing of IF signals through the controller from the two units. When there is an equipment failure, switching automatically takes place to protect the IF traffic circuit. Figure 1-2 illustrates the 1:1 redundancy switch connected in a 1:1 application with two modulators.

The 1:1 redundancy switch derives its operating power from the two modulators - Online and Standby. A diode sharing arrangement, with a current sharing circuit ensures that in normal operation power is taken equally from the two modulators. However, in the event that one of the two units is removed, the remaining unit supplies the entire current requirement. The Modulators supply +12 volts DC individually up to 160 mA max. The modulators employ electronic fuses, which prevent excessive current from being drawn by the 1:1 redundancy switch, should an anomalous condition occur.

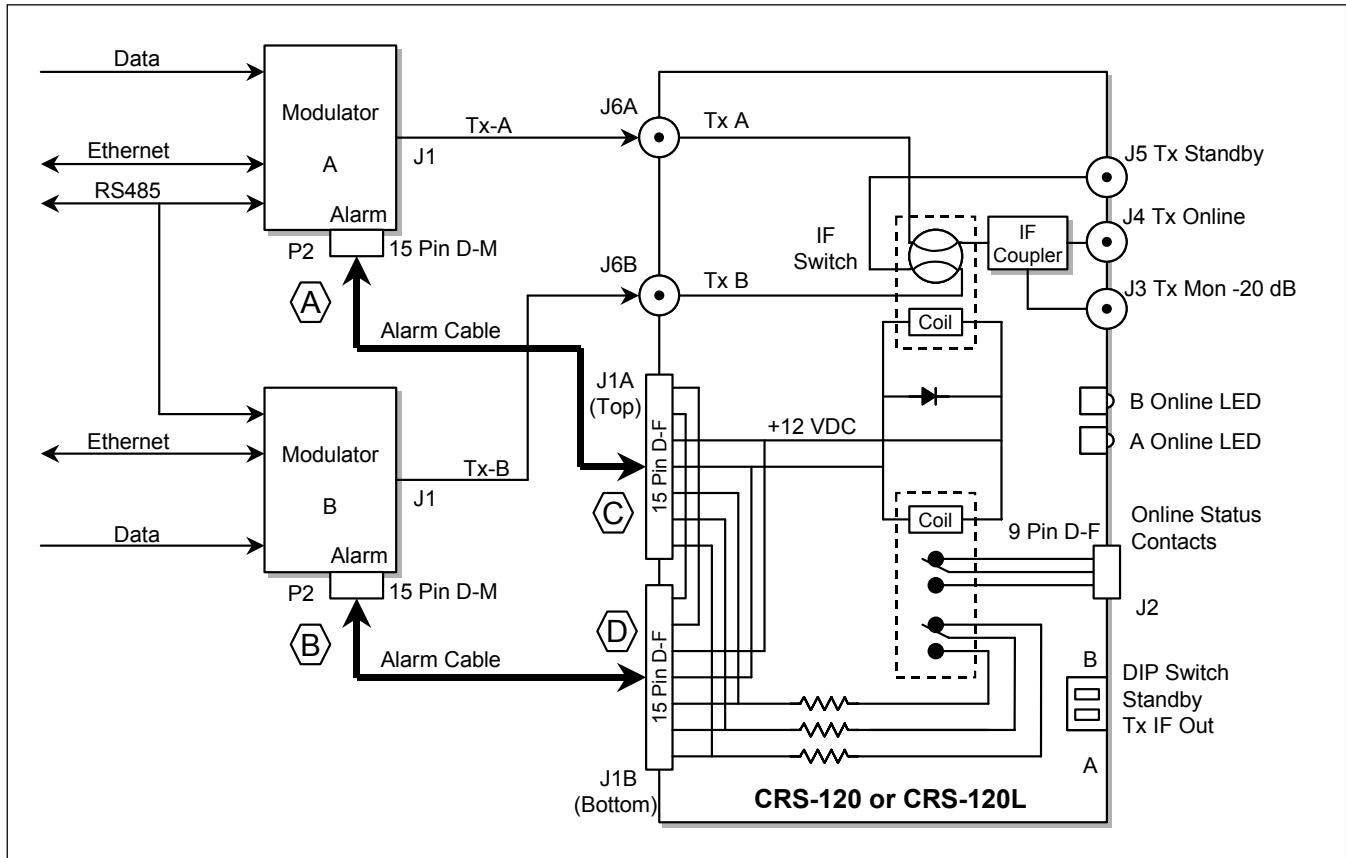

Figure 1-2. Block Diagram

The operating mode for the 1:1 subsystem is as follows:

Latching mode

The online (A) and standby (B) units are established with no faults. When a failure occurs in the online unit switchover occurs and there is no further switching unless there is intervention via the remote control or front panel.

There also are two selections for the Standby Tx-IF, Off and On (DIP switches are located on the 1:1 redundancy switch:

Standby Tx-IF = On

This is the default method of operation. With the On selection, the Standby Tx carrier remains ON provided no Tx or unit fault affecting the carrier is present.

Standby Tx-IF = Off

With this selection, only one modulator in the pair (the Online unit) is permitted to transmit its IF carrier signal at any one instant. The Standby unit is forced to disable its TX carrier because the switch applies the TX Carrier Off signal to the Standby unit. The CRS-120 provides further isolation (and security) by using an RF relay within the unit. The RF relay delivers a low loss signal from the IF port of the modulator to the Online port of the switch compared to the 3.5 dB loss introduced with methods that use a power combiner.

A special mode of operation is provided for 1:1 redundancy.

Loss Of Tx Data

A loss of Tx Data into the modulator will produce a fault into the modulator. Switchover occurs provided both units do not simultaneously lose Tx Data. In this mode, the loss of Tx Data does not turn off the Tx carrier. This alarm is masked under Alarm Mask section of the menus in the modulator.

Fault status information is fed from each of the two modulators, via the Alarms Interface connector. Based on the fault status the 'A' or 'B' is placed online. The 1:1 redundancy switch simultaneously indicates to the microcontroller within the Standby unit that the unit is no longer 'Online'. This results in the 'Online' LED on the front panel of the unit being extinguished. This status is also reported over the remote control bus, so an external M&C system can determine the state of the redundancy system. At the same time, a green LED will illuminate on the front of the 1:1 redundancy switch to indicate whether the 'A' or 'B' unit is Online.

The customer selects the operating modes within the modulators and their 1:1 controllers determine the conditions for switchover. By examining the fault status of both units, it is determined if the fault is external to the system.

1.3 Front Panel

The CRS-120 Switch: On the front panel (Figure 1-3) of the unit are the following IF connectors, which are BNC female:

- J3 Tx IF Mon 20dB, a sample of the Tx Online signal for test purposes
- J4 Tx IF Online, the output connector with the Tx Carrier
- J5 Tx IF Standby, which connects to the Standby modulator

The CRS-120L Switch: On the front panel (Figure 1-4) of the unit are the following connectors, which are SMA female:

- J3 20dB Mon, a sample of the Online signal for test purposes
- J4 Online, the output connector with the Tx Carrier
- J5 Standby, which connects to the Standby modulator

Additionally, on the front panel are two LEDs, marked ‘A Online’ and ‘B Online’. Only one of these LEDs will be illuminated at any given time, and provide a visual indication of which of the two units is presently carrying traffic. There also is a 9-pin D female connector (J2) with a set of From-C contacts to indicate whether A or B is online.

Also on the front panel is a ground stud, which may be used, if desired, to bond the chassis of the unit to the system ground. The front panel also contains mounting points to attach an optional 19-inch panel to secure the unit to rear of a cabinet if desired.

The front panel also contains DIP to select the whether a carrier is produced in an unfaulted Standby unit.

1.4 Rear Panel

Located on the rear panel are the two Alarm Interface connectors for the ‘A’ and ‘B’ units, each being 15-pin ‘D’ type female. These are connected to the Modulators using the two supplied cables.



REMEMBER!
The top unit is ‘A’
The bottom unit is ‘B’

The CRS-120L Switch: The CRS-120L (L-Band) has two connectors (J6A/J6B) ‘A’ and ‘B’, which are both SMA female. Connection is made to the pair of Modulators using coaxial cables with SMA-Male connectors.

1.5 Side Panel - Right Side

The CRS-120 Switch: On the side panel of the CRS-120 (70/140 MHz) to the right are the two TX IF ports (J6A/J6B), 'A' and 'B', which are both BNC female. Connection is made to the pair of Modulators using coaxial cables with BNC-Male connectors.

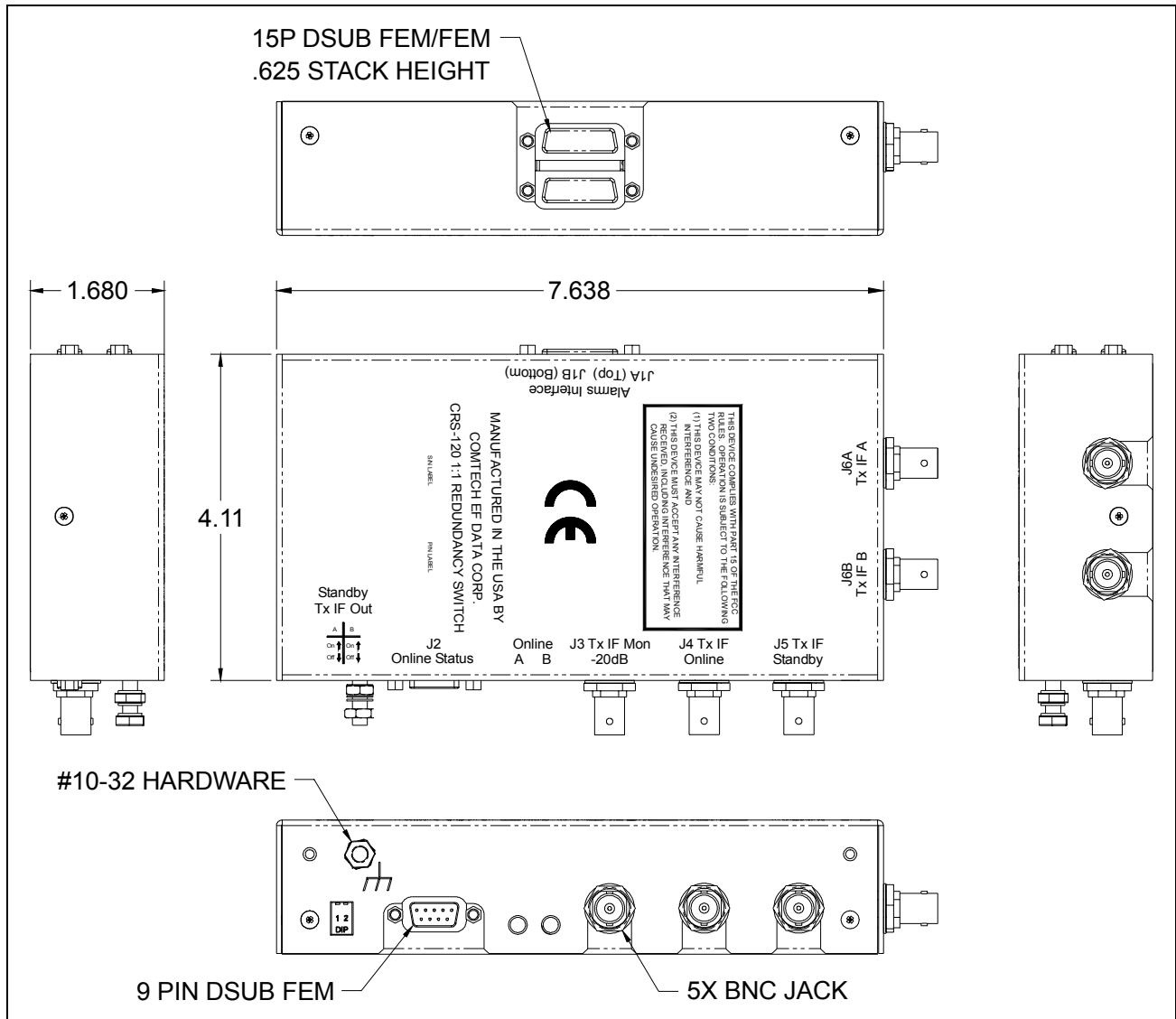

Figure 1-3. Dimensional Envelope of CRS-120 (P/L 10979-1)

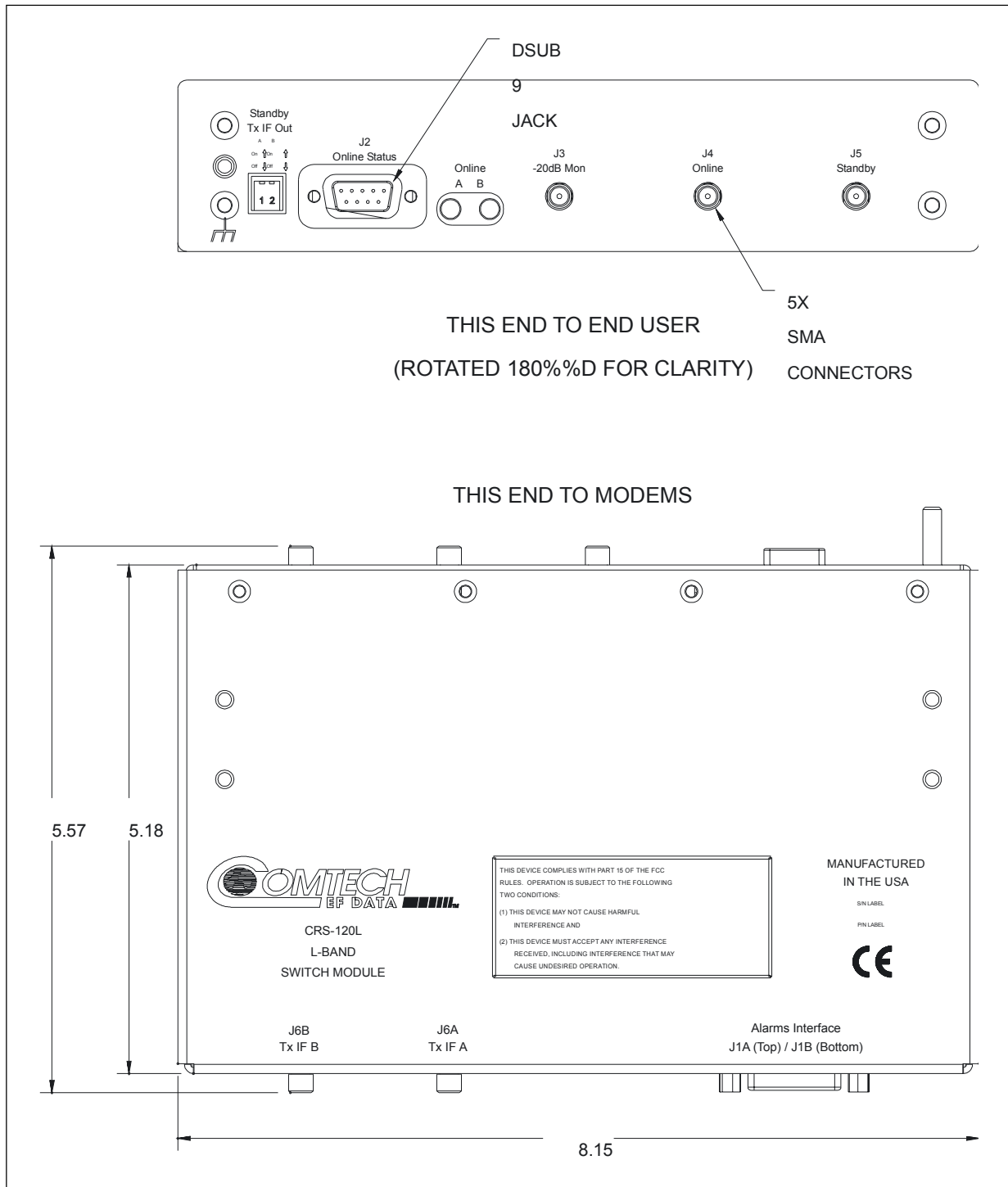

Figure 1-4. Dimensional Envelope of the CRS-120L (PL/11362-1)

This page is intentionally left blank.

Chapter 2. INSTALLATION

2.1 Unpacking

The switch and manual are packaged in pre-formed, reusable, cardboard cartons containing foam spacing for maximum shipping protection.



Do not use any cutting tool that will extend more than 1 inch into the container. This can cause damage to the modem.

Unpack the switch as follows:

1. Cut the tape at the top of the carton indicated by OPEN THIS END.
2. Remove the cardboard/foam space covering the switch.
3. Remove the switch, manual, and power cord from the carton.
4. Save the packing material for storage or reshipment purposes.
5. Inspect the equipment for any possible damage incurred during shipment.
6. Check the equipment against the packing list to ensure the shipment is correct.

2.2 Mounting

The 1:1 redundancy switch is designed to be connected and self-supporting at the rear of the two modulators. The two alarm cables provide this support, but in most rack installations additional support is usually provided by physically anchoring the connecting cables.

2.2.1 CRS-120 Optional Mounting Panel

An optional mounting panel (KT/11084-2) is available to attach the 1:1 redundancy switch to the standard 19-inch cabinet. Install Mounting Panel as follows:

1. Remove two bottom switch screws (Figure 2-1) and set a side.
2. Remove two upper switch screws and discard.
3. Remove grounding nuts and washers from grounding lug and set aside.
4. Position mounting panel onto switch.
5. Reinstall grounding nuts and washers previously removed.
6. Reinstall two bottom switch screws previously removed.
7. Install two kit screws (component of KT/11084-2) and secure.

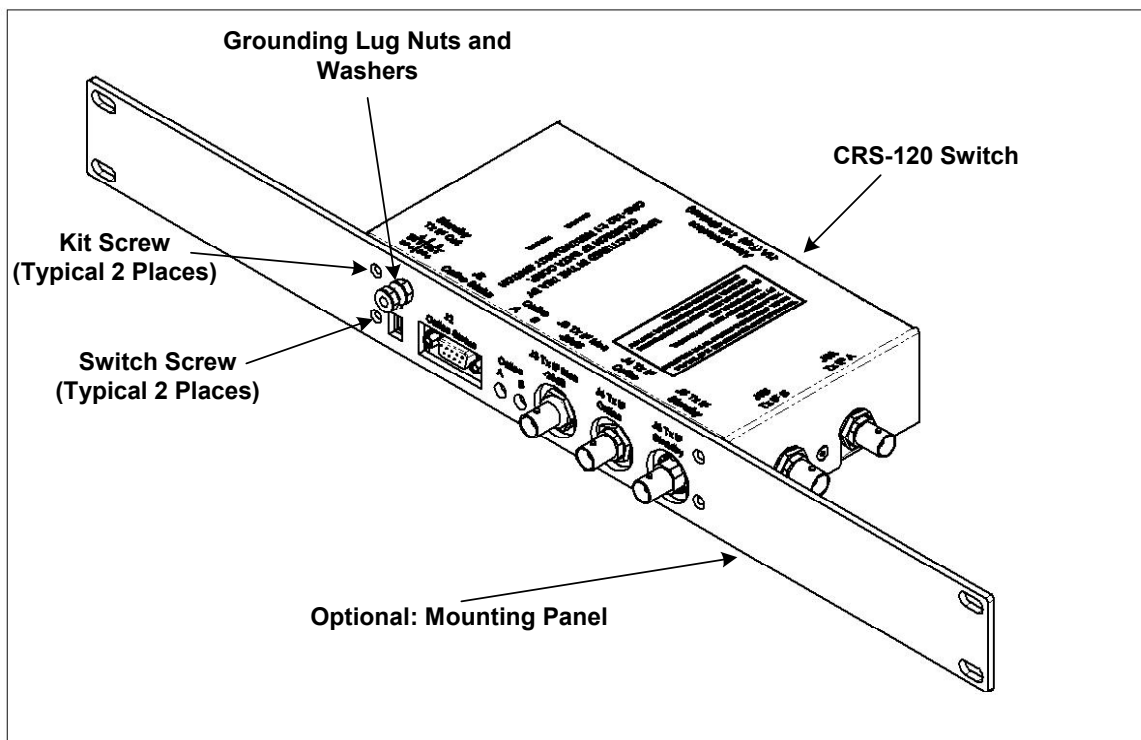

Figure 2-1. CRS-120 Optional Mounting Panel

2.2.2 CRS-120L Optional Mounting Panel

An optional mounting panel (KT/11362-2) is available to attach the 1:1 redundancy switch to the standard 19-inch cabinet. Install Mounting Panel as follows:

1. Remove two bottom switch screws (Figure 2-2) and set a side.
2. Remove the two upper switch screws and discard.
3. Remove grounding nuts and washers from grounding lug and set aside.
4. Position mounting panel onto switch.
5. Reinstall grounding nuts and washers previously removed.
6. Reinstall two bottom switch screws previously removed.
7. Install two kit screws (component of KT/11362-2) and secure.



Figure 2-2. CRS-120L Optional Mounting Panel

2.3 Connect External Cables

2.3.1 CRS-120 Wiring Connection

Figure 2-3 shows how to connect a pair of Modems together with the 1:1 redundancy switch.

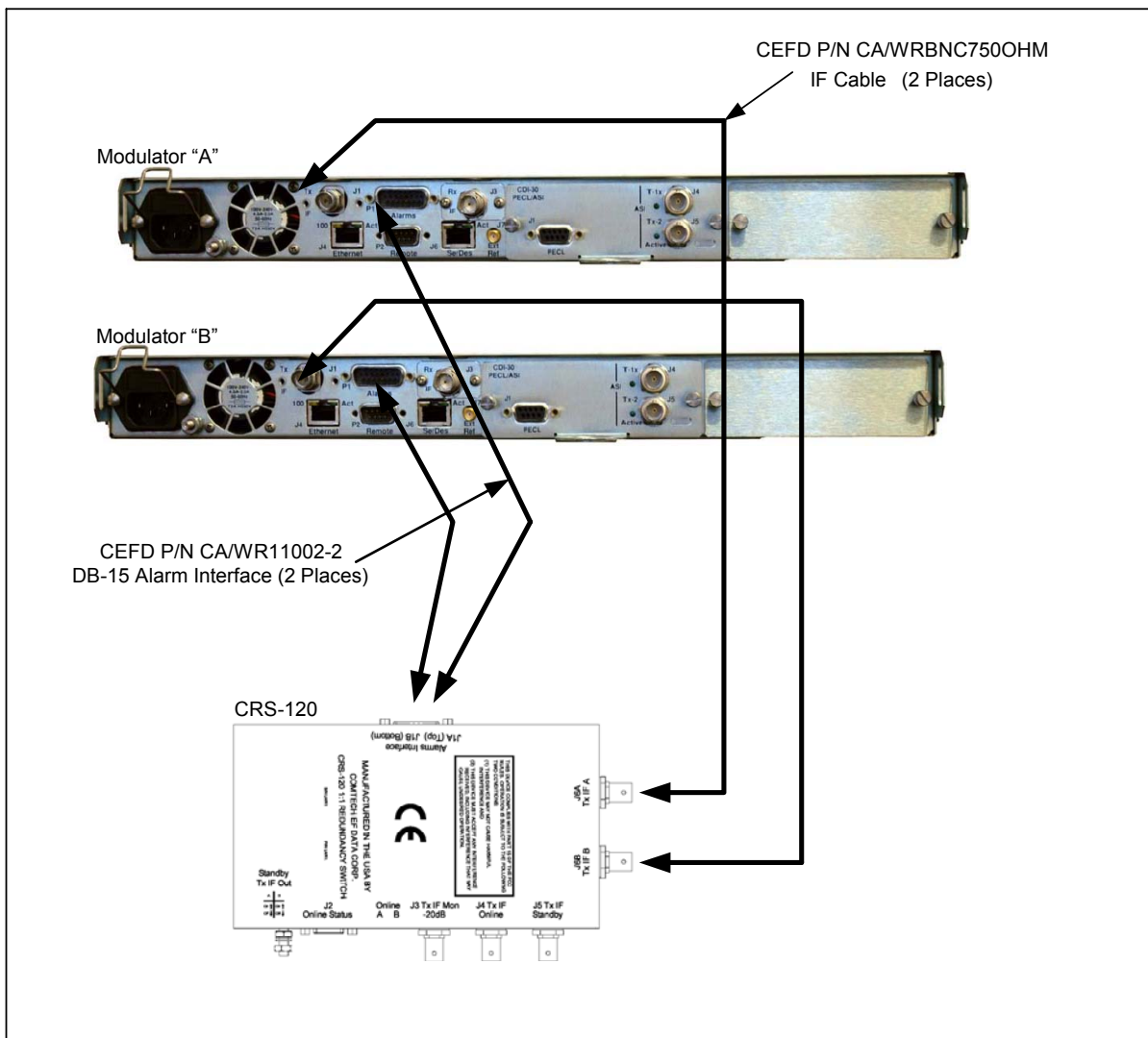

Figure 2-3. CRS-120 Typical Installation

2.3.2 CRS-120L Wiring Connection

Figure 2-4 shows how to connect a pair of Modems together with the 1:1 redundancy switch.

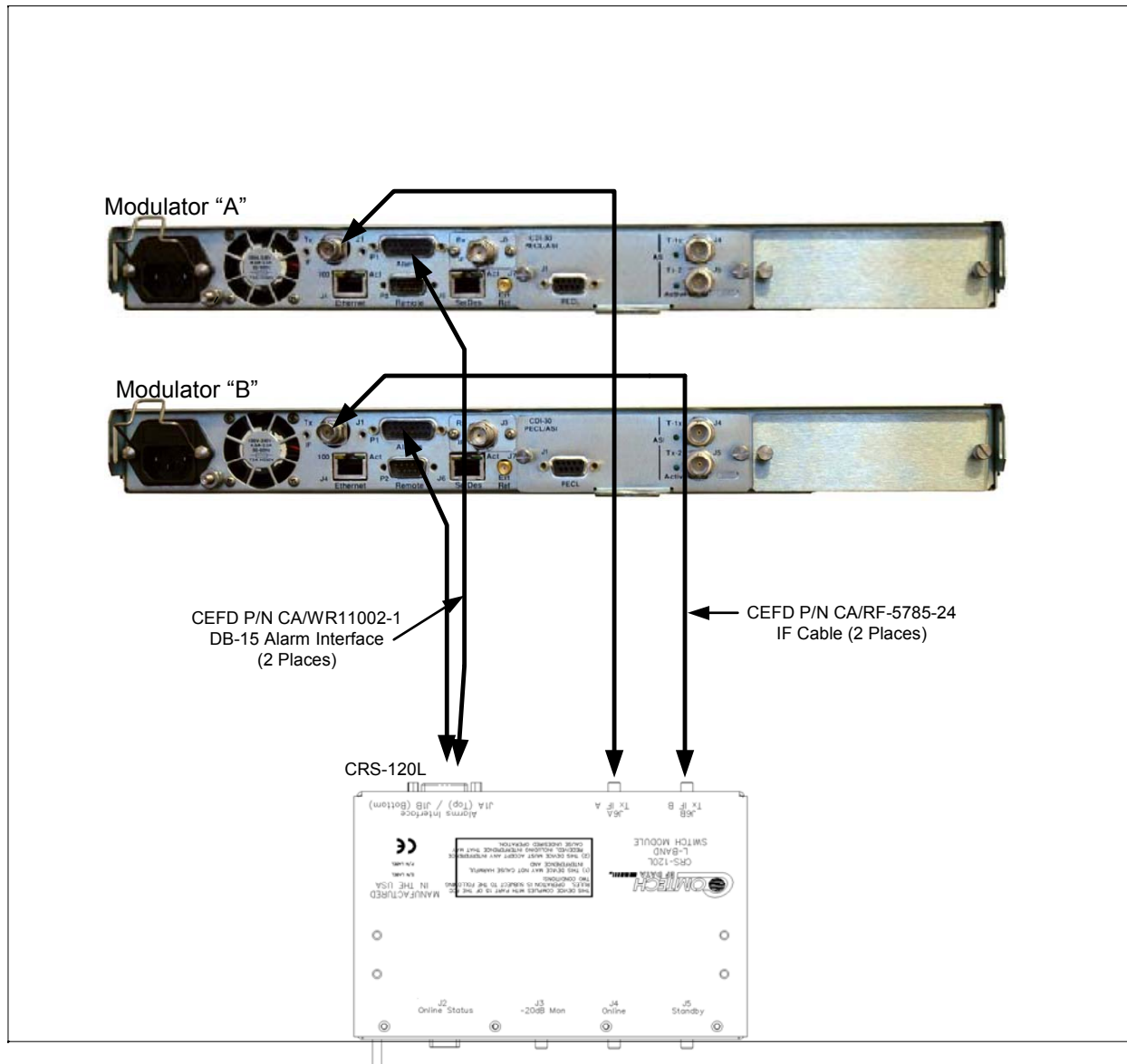

Figure 2-4. CRS-120L Typical Installation

The following cable assemblies are available with the 1:1 redundancy switch as shown in the preceding figure:

Qty	Cable, P/N	Remarks
CRS-120		
2	CA/WR11002-2	Cable Assy, Alarms Interface
2	CA/BNC75OHM	CEFD, 75Ω IF Cable
REF	KT/11084-3	CRS-120 Switch Kit (including cabling)
CRS-120L		
2	CA/WR11002-2	Cable Assy, Alarms Interface
2	CA/RF-5785-24	CEFD, L-Band Cable
REF	KT/11362-3	CRS-120L Switch Kit (including cabling)

For CRS-120 Switch: The 1:1 redundancy switch is designed to work with 75Ω systems, and Users should ensure that they order the correct IF cable sets.

For CRS-120L Switch: The 1:1 redundancy switch is designed to work with 50Ω systems, and users should ensure that they order the correct L-Band cables.

The modulator connected to the J1A (top) connector of the 1:1 redundancy switch is recognized as the A unit and the one connected to J1B is the B unit. When a modulator is plugged in and detected the main menu of the front panel display automatically indicates whether the modem is A or B.

It is essential to ensure that the IF connections, are made correctly, ie the TX IF from Unit ‘A’ connects to the TX IF port ‘A’ on the 1:1 redundancy switch, and Unit ‘B’ to ‘B’. Failure to observe this requirement will result in the system malfunctioning.



When connecting the Alarms Interface cable between the 1:1 redundancy switch and the modulators, please ensure that screw locks on the ‘D’ type connectors are securely fastened. This will prevent the accidental un-mating of the cable, particularly when a Standby unit is being removed or replaced.

Chapter 3. CONNECTOR PINOUTS

3.1 External Modem Connections

The external connectors provide all necessary connections between the 1:1 switch and other equipment. Refer to Figures 1-3 and 1-4 for appropriate connector locations.

Table 3-1. CRS-120 Connectors and Pin Assignments

Name	Reference	Connector Type	Function
Alarm Interface, Top	J1A	15-Pin D Sub/Female	
Alarm Interface, Bottom	J1B	15-Pin D Sub/Female	
Online Status	J2	9-Pin D Sub/Female	
TX-IF MON	J3	BNC Female	
TX-IF Online	J4	BNC Female	
TX-IF Standby	J5	BNC Female	
TX IF A	J6A	BNC Female	
TX IF B	J6B	BNC Female	
Ground	GND	10-32 Stud	

Table 3-2. CRS-120L Connectors and Pin Assignments

Name	Reference	Connector Type	Function
Alarm Interface, Top	J1A	15-Pin D Sub/Female	
Alarm Interface, Bottom	J1B	15-Pin D Sub/Female	
Online Status	J2	9-Pin D Sub/Female	
-20 dB MON	J3	SMA Female	
Online	J4	SMA Female	
Standby	J5	SMA Female	
TX IF A	J6A	SMA Female	
TX IF B	J6B	SMA Female	
Ground	GND	10-32 Stud	

3.1.1 Alarm Interface Pin Assignment, J1A, J1B

The Alarm connector is a 15-Pin D female type, with threaded jack nuts. The pinout depends upon whether the unit is in the Normal or Redundancy mode.

Alarm A (J1A) or B (J1B) Connector

1:1 Mode (In Modulator)				
Pin #	Description	Name	J1A Direction	J1B Direction
8	Program Relay NC	PR-NC	I/O	I/O
15	Program Relay NO	PR-NO	I/O	I/O
7	Program Relay COM	PR-COM	I/O	I/O
14	Rx Fault (De-energized = Open = Fault)	Rx_-NO	I/O	I/O
6	Tx Fault (De-energized = Open = Fault)	Tx_-NO	I/O	I/O
13	Unit Fault (De-energized = Open = Fault)	Unit_-NO	I/O	I/O
5	Mod A/D	MODA2D	O	O
12	+12 VDC Output (160 ma)	+12Vout	I	I
4	AUX0 Out Enable to 1:N	Tx_B_EN	I	I
11	Rx I Channel (Constellation Monitor)	Rx-I	I	I
3	Rx Q Channel (Constellation Monitor)	Rx-Q	I	I
10	RS-232 OH Channel Input	Tx Aux_RS232	O	I
2	RS-232 OH Channel Output	Rx Aux_RS232	I	O
9	Ext Carrier Off	EXT-OFF	O	O
1	Ground	GND	Gnd	Gnd

Note: Items shown (NC) are not connected inside the switch.

3.1.2 Online Status Connector Pin Assignments, J2

The Indicator connector is a 9-Pin D female type, with threaded jack nuts.

Pin #	Description	Direction
1	Ground	I/O
2		
3		
4	B-NO (COM to NO, B is Online)	I/O
5	A/B-COM	I/O
6	A/B-NC (COM to NC, A is Online)	I/O
7		
8		
9		

3.1.3 CRS-120 Only. TX-IF Connectors, J3, J4, J5, J6A, J6B

Ref Des	Name	Function
J3	Tx IF MON -20 dB	Output, monitors online carrier at approximately -20 dB.
J4	Tx IF Online	Output, Online Carrier
J5	Tx IF Standby	Output, Standby Carrier
J6A	Tx IF A	IF Input from Modulator A,
J6B	Tx IF B	IF Input from Modulator B

3.1.4 CRS-120L only. SMA Connectors J3, J4, J5, J6A, J6B

Ref Des	Name	Function
J3	-20 dB MON	Output, monitors online carrier at approximately -20 dB.
J4	Online	Output, Online Carrier
J5	Standby	Output, Standby Carrier
J6A	Tx IF A	Input from Modulator A,
J6B	Tx IF B	Input from Modulator B

3.1.5 Standby TX IF Out Switch

The switch is a 2-position Dip switch. This switch enables or disables the standby Tx Carrier provided there is no fault that will normally disable the carrier.

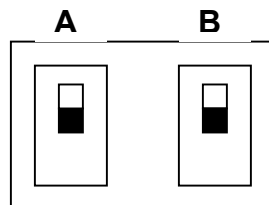

↑ (up position) Standby Tx carrier remains On

↓ (down position) Standby Tx carrier is forced Off.

Chapter 4. OPERATION

4.1 Introduction

Having connected the cables in accordance with the instructions and diagram specified in Section 2.0, the User is now ready to put the system into operational use. Before proceeding, the User should check that the Alarm cable from each modulator to the 1:1 redundancy switch is functioning correctly. From the front panel of the Online unit, access the main menu, and then select **Config: Aux: 1:1 Mode**.



Figure 4-1. Typical View of Modulator Front Panel

4.2 1:1 Operation

After the unit has been cabled in accordance with the instructions and diagram specified in Section 3.0, the User is ready to initiate operational use. Before proceeding, the User should check that the Auxiliary Serial link between the two units is functioning correctly. The opening screen of the modulator indicates whether the modulator is the A or B unit.

```
CDM-710 Modulator  A
Firmware Version X.X.X
```

The bottom line displays the internal software version. Press [ENTER] to go to the Main menu screen.



Once the modulator is set up for proper operation, the character 'A, B, or ?' will appear in the display, when the unit is enabled for 1:1 operation to designate the A or B modulator or ? to indicate a cable is most likely disconnected.

From the front panel of the Online unit, access the Main menu, and then select **Config: Aux: 1:1 Mode**.

Config: AUX: 1:1 Mode

The Aux: 1:1 menus are used to set up 1:1 operation with the 1:1 redundancy switch.

```
1:1 Mode: Ena/Dis
Auto/Man  Force  (◀ ▶ E)
```

Config: AUX: 1:1 Mode: Enable / Disable

```
1:1 Enable/Disable:
Enable Disable (◀ ▶ E)
```

Selecting **Enable** sets up the unit for operation with the 1:1 IF switch. Internally an auxiliary relay sets the alarms connector for the 1:1 operation mode. This permits the modulator to automatically detect the presence of the 1:1 switch and determine if it is the **A** (Online) or **B** (Standby) unit.

The **Main** menu indicates the **A** or **B** unit. If **A** or **B** is opposite of what is expected the Alarm cables connecting the unit at the 1:1 switch are probably swapped. A **?** appears in

the **Main** menu if 1:1 operation is enabled and the modulator cannot sense **A** or **B** status. This usually indicates the cable is disconnected.

Config: AUX: 1:1 Mode: Switching

```
1:1 Mode Switching:  
Auto- (On)  Manual- (Off)  (◀ ▶ E)
```

Selecting Auto-(On) places the 1:1 switching in the automatic mode. The Manual-(Off) mode disables automatic operation.

Config: AUX: 1:1 Mode: Force

```
Press ENT to Force Modem to Standby  
(1:1 Only)
```

This menu allows forced switchover.

4.3 1:1 Remote Control Operation

From the front panel of the Online unit, access the Main menu, then select: **Config: Remote Control** menu to set up the modulator for operation via the remote port. Also refer to the Remote Operation section for commands and responses. Setup for remote operation is as follows:

If **RS485** was selected, the user will be further prompted:

```
RS485 Address:  
Modulator  Switch
```

This menu allows selection of a **Modulator** address and **Switch** address. The **Switch** address is used in conjunction with CRS-120 IF Switch in 1:1 applications where two modulators share the switch controller function and drive the IF switch to place the A modulator or B modulator in the Online or Standby positions.

Operationally, each modulator has a unique modulator address but they share a common switch address.

If **Modulator** is selected, the user is further prompted:

```
RS485 Mod Address: 0001
( ◀ ▶ ▲ ▼ E)
```

Edit the RS485 Mod address of this modulator. This is accomplished by selecting the digit to be edited, using the ◀ ▶ arrow keys. The value of the digit is then changed using the ▲ ▼ arrow keys. The user should then press [ENTER]. The valid range of addresses is from 1 to 9999.

If **Interface** was selected:

```
M&C Bus Interface: RS232
RS485-2W RS485-4W ( ◀ ▶ E)
```

Select **RS232** or **RS485-2W** (2-wire) or **RS485-4W** (4-wire) using the ◀ ▶ arrow keys, then press [ENTER].

Note: At this point the user will be further prompted to enter the bus address.

Chapter 5. SUMMARY OF SPECIFICATIONS

5.1 Summary of Specifications

Note: Specifications for the CRS-120 and CRS-120L are shown in their respective tables.

5.1.1 CRS-120 Summary of Specifications

Table 5-1. CRS-120 Summary of Specifications

Description	Requirements
Equipment Type	1:1 Redundancy Switch
Modulators Supported	CDM-710 Satellite Modulator (70/140 MHz)
Operating Modes	Fully automatic Manual (via the front panel of the Online Modulator, or via the Modulator's remote control interface)
Architecture	Continuous fault comparison of Online and Standby units. Switchover only to an unfaulted unit
Switch Conditions	Switchover initiated following: Unit faults or loss of Tx Traffic
Fault detection time	0.5 seconds maximum (time to detect a fault)
Switchover time	Within 0.5 seconds of fault detection (time for relay to switch)
IF Frequency Range	52 - 176 MHz (works with both 70 and 140 MHz Modulator IF options)
IF Impedance	75 Ω
IF Connectors	BNC female
Return Loss	18 dB minimum from Tx-Online to the online Tx-A or Tx-B
Tx Insertion Loss	1.0 dB maximum, Tx-A or Tx-B to Tx-Online in low isolation position 1.0 dB maximum Tx-A or Tx-B to the Tx-Standby in low isolation position
Tx Sample	-20 dB typical below Tx-Online signal
Tx Isolation	45 dB minimum Tx-A or Tx-B to Tx-Online in the high isolation position 45 dB minimum Tx-A or Tx-B to Tx-Standby in the high isolation position
Indicator Contacts	9 pin D female connector with Form-C contacts indicating A or B is Online Contacts are 30 VDC at 1 Amp maximum
Indicator LED	Two Green LEDs one indicates A Online the other indicates B Online
De-Energized State	With no power applied A is Online
Synchronization	The Standby absorbs the configuration of the Online unit (1:1 mode enabled)
Weight	1.1 lbs (0.5 kg)
Dimensions	1.7H x 7.64W x 4.11D inches (4.3H x 19.4W x 10.4D cm) See Section 1 for dimensional outline drawings.
Power requirements	1.2 Watts maximum + 12 volts DC @ 100 mA (max) (Power is supplied by the Online and Standby Modulators, and the unit current shares when both an 'A' and 'B' unit are present. These power supplies are electronically fused and protected.) A single modulator has capacity to source the required current.
Agency Approvals	CE: emissions, susceptibility and safety

5.1.2 CRS-120L Summary of Specifications

Table 5-2. CRS-120L Summary of Specifications

Description	Requirements
Equipment Type	1:1 Redundancy Switch
Modulators Supported	CDM-710 Satellite Modulator (L-Band)
Operating Modes	Fully automatic Manual (via the front panel of the Online Modulator, or via the Modulator's remote control interface)
Architecture	Continuous fault comparison of Online and Standby units. Switchover only to an unfaulted unit
Switch Conditions	Switchover initiated following: Unit faults or loss of Tx Traffic
Fault detection time	0.5 seconds maximum (time to detect a fault)
Switchover time	Within 0.5 seconds of fault detection (time for relay to switch)
IF Frequency Range	950 - 1750 MHz
IF Impedance	50Ω
IF Connectors	SMA female
Return Loss	18 dB minimum from Tx-Online to the online Tx-A or Tx-B
Tx Insertion Loss	1.9 dB maximum, Tx-A or Tx-B to Tx-Online in low isolation position 1.9 dB maximum Tx-A or Tx-B to the Tx-Standby in low isolation position
Tx Sample	-20 dB typical below Tx-Online signal
Tx Isolation	45 dB minimum Tx-A or Tx-B to Tx-Online in the high isolation position 45 dB minimum Tx-A or Tx-B to Tx-Standby in the high isolation position
Indicator Contacts	9 pin D female connector with Form-C contacts indicating A or B is Online Contacts are 30 VDC at 1 Amp maximum
Indicator LED	Two Green LEDs one indicates A Online the other indicates B Online
De-Energized State	With no power applied A is Online
Synchronization	The Standby absorbs the configuration of the Online unit (1:1 mode enabled)
Weight	1.1 lbs (0.5 kg)
Dimensions	1.7H x 8.15W x 5.57D inches (4.3H x 20.7W x 14.1D cm) See Section 1 for dimensional outline drawings.
Power requirements	1.2 Watts maximum + 12 volts DC @ 100 mA (max) (Power is supplied by the Online and Standby Modulators, and the unit current shares when both an 'A' and 'B' unit are present. These power supplies are electronically fused and protected.) A single modulator has capacity to source the required current.
Agency Approvals	CE: emissions, susceptibility and safety

5.2 1:1 Latching Operation

Table 5-3 explains two cases and how the health of 1:1 subsystem is monitored.

Event	Mod A	Mod B	RF Relay	Comments	Notes
Case 1					
1	OK (Online)	OK (Standby)	A	The online and standby units are designated. Tx IF = A	1, 2, 7, 8
2	Fault	OK	B	A Faults and B is OK, switches to B. Tx IF = B	3, 4, 9, 10
3	Fault	Fault	B	Fault in A and B. Tx IF = None (carriers muted by both modulators).	3, 4, 9, 10
4	OK	Fault	B	Requires intervention. Tx IF = None (A is Standby and B carrier is muted by modulator).	3, 4, 9, 10
5	OK	OK	B	Requires intervention. Tx IF = B.	3, 4, 9, 10
Case 2					
6	OK (Online)	OK (Standby)	A	The online and standby units are designated. Tx IF = A	1, 2, 7, 8
7	OK	Fault	A	A is OK and B Faults. Tx IF = A.	1, 2, 5, 6, 11, 12
8	Fault	Fault	A	Fault in A and B. Switchover to a failed unit is not allowed. Tx IF = None, and both carriers are muted.	1, 2, 5, 6, 11, 12

Notes:

Removal of the Alarm Cable while power is ON to both modulators:

1. Disconnecting the cable at A switches the B unit online and an alarm is reported. Reconnecting the cable at A maintains the B unit online.
2. Disconnecting the cable at B keeps A online and an alarm is reported. Reconnecting the cable to B keeps A online.
3. Disconnecting the cable at A maintains the B unit online and an alarm is reported. Reconnecting the cable to A maintains the B unit online.
4. Disconnecting the cable at B maintains B online and an alarm is reported. Reconnecting the cable to B keeps B online.
5. Disconnecting the cable at A maintains the A unit online and an alarm is reported. Reconnecting the cable at A maintains the A unit online.
6. Disconnecting the cable at B keeps A online and an alarm is reported. Reconnecting the cable to B keeps A online.

Power OFF/ON to modulators while both Alarm cables connected:

7. Turning OFF power only to the A modulator switches the B unit online and an alarm is reported. When power is returned to A the B unit stays online.
8. Turing OFF power only to the B unit maintains the A unit online. Restoring power to the B unit maintains the A unit online.
9. Turning OFF power only to the A modulator maintains the B unit online and an alarm is reported. When power is returned to A the B unit stays online.
10. Turning OFF power only to the B modulator maintains B online. Restoring power to the B unit maintains B online.
11. Turning OFF power only to the A modulator maintains the A unit online. Connecting power to the A unit maintains A online.
12. Turing OFF power only to the B unit maintains the A unit online. Restoring power to the B unit maintains the A unit online

5.3 Tx Online Status Contacts

There are Form C indicator contacts that report whether A or B is online. These are “clean” contacts that are not used by the modulator or switch. These are located on the front panel of the CRS-120 Switch.

This page is intentionally left blank.

METRIC CONVERSIONS

Units of Length

Unit	Centimeter	Inch	Foot	Yard	Mile	Meter	Kilometer	Millimeter
1 centimeter	—	0.3937	0.03281	0.01094	6.214×10^{-6}	0.01	—	—
1 inch	2.540	—	0.08333	0.2778	1.578×10^{-5}	0.254	—	25.4
1 foot	30.480	12.0	—	0.3333	1.893×10^{-4}	0.3048	—	—
1 yard	91.44	36.0	3.0	—	5.679×10^{-4}	0.9144	—	—
1 meter	100.0	39.37	3.281	1.094	6.214×10^{-4}	—	—	—
1 mile	1.609×10^5	6.336×10^4	5.280×10^3	1.760×10^3	—	1.609×10^3	1.609	—
1 mm	—	0.03937	—	—	—	—	—	—
1 kilometer	—	—	—	—	0.621	—	—	—

Temperature Conversions

Unit	° Fahrenheit	° Centigrade
32° Fahrenheit	—	0 (water freezes)
212° Fahrenheit	—	100 (water boils)
-459.6° Fahrenheit	—	273.1 (absolute 0)

Formulas
$C = (F - 32) * 0.555$
$F = (C * 1.8) + 32$

Units of Weight

Unit	Gram	Ounce Avoirdupois	Ounce Troy	Pound Avoir.	Pound Troy	Kilogram
1 gram	—	0.03527	0.03215	0.002205	0.002679	0.001
1 oz. avoir.	28.35	—	0.9115	0.0625	0.07595	0.02835
1 oz. troy	31.10	1.097	—	0.06857	0.08333	0.03110
1 lb. avoir.	453.6	16.0	14.58	—	1.215	0.4536
1 lb. Troy	373.2	13.17	12.0	0.8229	—	0.3732
1 kilogram	1.0×10^3	35.27	32.15	2.205	2.679	—



2114 WEST 7TH STREET TEMPE ARIZONA 85281 USA
480 • 333 • 2200 PHONE
480 • 333 • 2161 FAX